



Hubbell Lighting, Inc.



The NYX Series

INSTRUCTIONS

IMPORTANT SAFEGUARDS

When using electrical equipment, basic safety precautions should always be followed including the following:

1. **READ AND FOLLOW ALL SAFETY INSTRUCTIONS**
2. Disconnect power before performing work on electrical equipment
3. Do not use outdoors
4. Do not let power cords touch hot surfaces and do not mount near gas or electric heaters.
5. Use caution when servicing batteries. Battery acid can cause burns to skin and eyes. If acid is spilled on skin or eyes, flush with fresh water and contact a physician immediately.
6. Equipment should be mounted in locations and at heights where unauthorized personnel will not readily subject it to tampering.
7. The use of accessory equipment not recommended by Dual-lite, may cause an unsafe condition, and will void the unit's warranty.
8. Do not use this equipment for other than its intended purpose.
9. Servicing of this equipment should be performed by qualified service personnel.
10. **SAVE THESE INSTRUCTIONS!**

INSTALLATION

WALL MOUNT - SINGLE FACE:

1. Extend unswitched 24 hour AC supply of rated voltage to junction box or appropriate wiring (supplied by others). Leave at least eight (8) inches of slack wire. The circuit should not be energized at this time.
2. Remove the exit sign faceplate by unscrewing the faceplate cover screw and sliding the faceplate down and out of the exit frame (Figure 2). Take care not to damage red fibre which is loose behind exit faceplate.
3. Remove the exit sign universal canopy kit.
4. Knock out the appropriate mounting pattern and/or wire pass-thru hole on the exit back plate to fit the junction box or wiring connector being used (supplied by others).
5. Bring wires through the back of the sign and mount the exit securely in place. Screw directly to junction box if possible.
6. Connect AC supply per diagram provided (Figure 5). **Insulate unused wire!**
CAUTION! - Failure to insulate unused wire may result in a shock hazard or unsafe condition as well as equipment failure.
7. Connect the battery to the circuit board. The LED lamps may come on at this time (depends on battery charge).
8. Route wires and secure them in place.
9. Remove any directional chevron arrows to be indicated as required from the exit stencil.
10. Replace the exit faceplate together with red fibre and secure with the faceplate cover screw.
11. Turn on the AC voltage supply.

CEILING/END MOUNT - SINGLE OR DOUBLE FACE:

1. Follow steps 1 to 3 of Wall Mounting instructions above.
2. If double face is required then remove the backplate cover screw and slide the backplate down and out from exit frame. Exits signs that are specified double face will already have the second/rear faceplate installed.
3. On the top and both sides of the exit there are three (3) holes for the canopy - two (2) for the mounting screws and one (1) wire pass-thru hole. Knock out the three appropriate canopy mounting holes for your installation (Figure 3).
4. Secure the canopy to the exit sign using the supplied 1 inch screws and washer nuts and the snap the wire pass-thru hole plastic bushing into the wire pass-thru hole in the centre of the canopy (Figure 3).
5. Bring wires through the wire pass-thru and connect AC supply as described in step 6 of Wall Mounting instructions above.
6. Secure the exit to the wall or ceiling using the supplied 1 1/2 inch screws and nuts. Screw directly to junction box if possible. A universal spider plate is supplied to allow for exit sign placement adjustment or connection to a variety of electrical boxes (Figure 4).
7. For double face exits install the second/rear faceplate and red fibre and secure with the back plate cover screw.
8. Follow steps 7 to 11 of Wall Mounting instructions above.

CAUTION

Before full load testing, allow battery 24 hours to complete full recharge following the turn on of AC power.

Figure 1

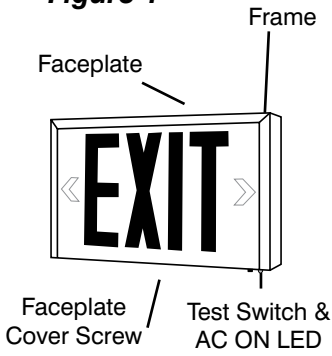

Figure 2

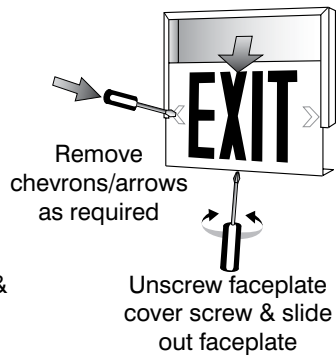

Figure 3

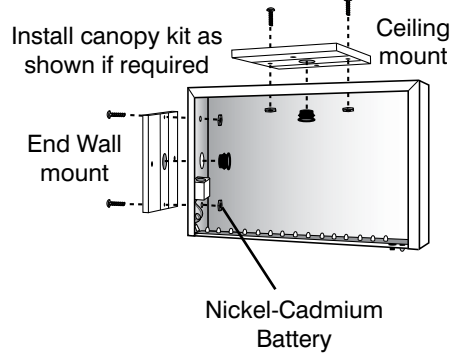

Figure 4

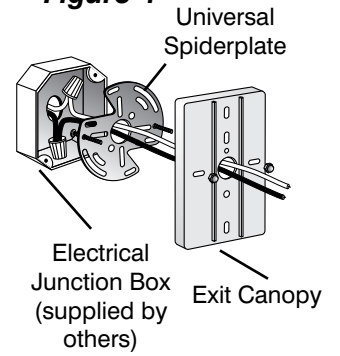
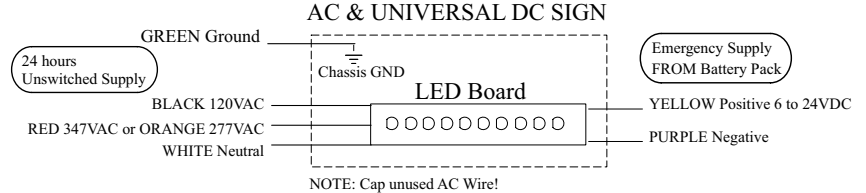
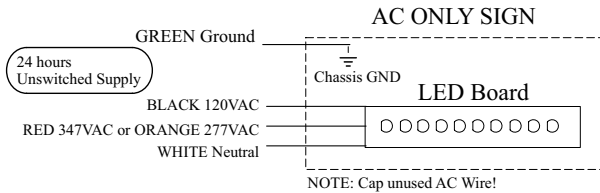
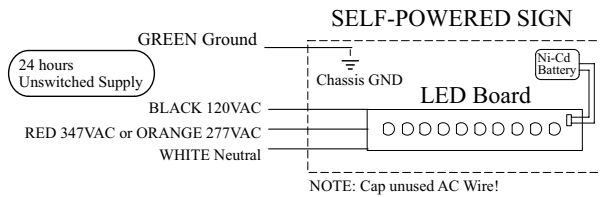
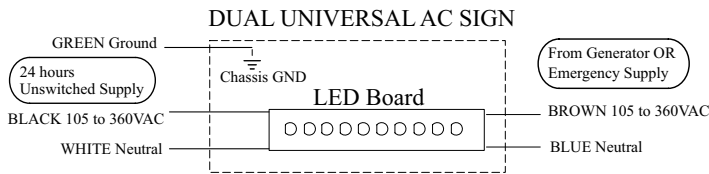

Figure 5



OPERATION

1. Depress the TEST switch. The LED "AC ON" indicator will go out and faceplate LEDs will remain illuminated.
2. Release the TEST switch. The LED "AC ON" indicator will come back on.

MAINTENANCE

1. Code requires that the equipment be tested every 30 days for 30 seconds, and that written records be maintained. Further, the equipment is to be tested once a year for 90 minutes duration as per Code. The equipment is to be repaired whenever the equipment fails to operate as intended during the duration test. Written records of test results and any repairs made must be maintained. Dual-Lite strongly recommends compliance with all Code requirements.
2. Clean exit face(s) on a regular basis.

NOTE: The servicing of any parts should be performed by qualified service personnel only. The use of replacement parts not furnished by Dual-Lite may cause equipment failure and will void the warranty.

TROUBLESHOOTING

EXIT SIGN DOES NOT COME ON AT ALL

LED "AC ON" indicator is out before test...

1. Check AC supply and all AC connections - be sure exit has 24 hour AC supply (unswitched). LED "AC ON" indicator on before test

2. Either the battery is shorted or the battery is not connected.

3. Battery is severely discharged. Allow 24 hours for recharge and then retest. NOTE: This could be the result of a switched AC supply to the unit (which has been turned off at some point), a battery with a shorted cell, an old battery or a battery which has been discharged due to a long power outage and is not yet fully recharged.

EXIT SIGN COMES ON DIM WHEN TEST BUTTON IS PRESSED

1. Battery discharged - permit the battery to recharge for 24 hours and then retest. If lamps are still dim, replace battery.

EXIT SIGN COMES ON DIM WHEN AC POWER IS ON

1. Check supply voltage and AC connections. This emergency light is provided with brownout protection. The AC supply must be at least 80% of nominal (96V on a 120V line) for equipment to function normally. At lower voltages the emergency lamps will begin to glow dimly until the source voltage drops below the full "turn-on" point.

NOTE: This condition may also be caused by incorrectly connecting a 120 Volt supply line to the 277-Volt transformer lead.

SAVE THESE INSTRUCTIONS